

Select your Milan model from the mediatechnologies Milan price sheet by model number.

Follow the Step-by-Step method to tell us how you want your Milan finished. Make sure you indicate your finish choice for each step below in your purchase order. We will list your choices as notes below each individual model number in your order acknowledgement.

A break down of the Milan model number is shown to the right.

Note: Transaction Top Left or Right is determined by the perspective of the user.

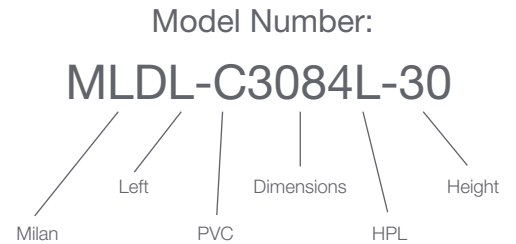

Step 1: Select HPL for work surface.

See our selection of finish choices at <https://www.mediatechnologies.com/resources/finishes>

Enter your selection on “Work Surface HPL” line on the last page of this designator.

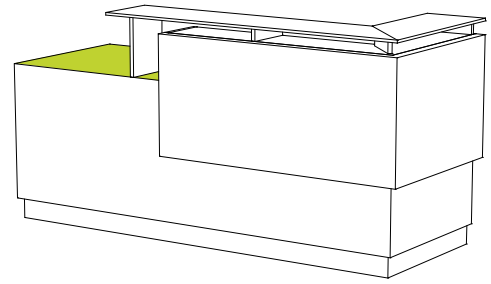

Step 2: Select HPL for main desk unit.

See our selection of finish choices at <https://www.mediatechnologies.com/resources/finishes>

Enter your selection on “Main HPL” line on the last page of this designator.

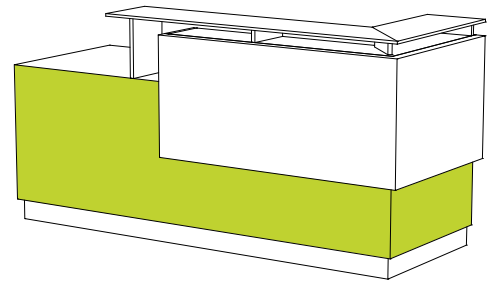

Step 3: Select HPL for Accent Box Panels.

See our selection of finish choices at <https://www.mediatechnologies.com/resources/finishes>

Enter your selection on “Accent HPL” line on the last page of this designator.

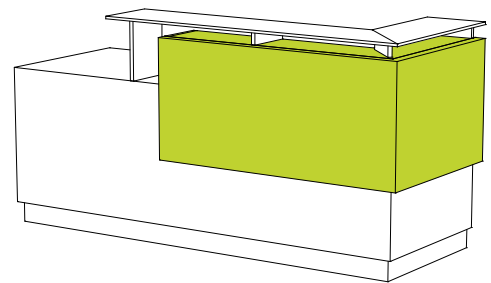

“How do I add finishes to...”

Milan

Step 4: Select HPL for work surface and transaction top surface.

See our selection of finish choices at <https://www.mediatechnologies.com/resources/finishes>

Enter your selection on “Transaction HPL” line on the last page of this designator.

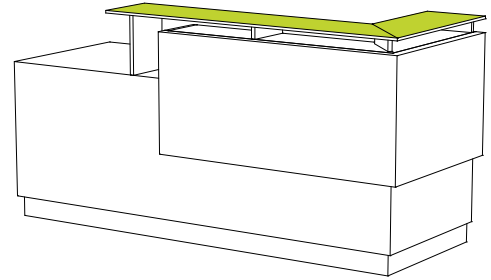

Step 5: Select PVC for transaction top.

See our selection of finish choices at <https://www.mediatechnologies.com/resources/finishes>

Enter your selection on “Transaction PVC” line on the last page of this designator.

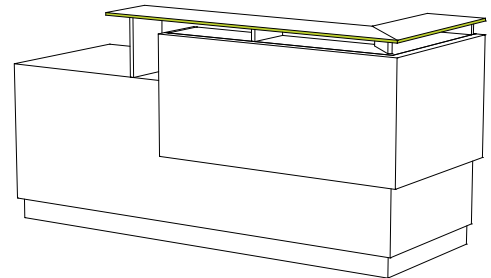

Step 6: Select HPL for Support Panels.

See our selection of finish choices at <https://www.mediatechnologies.com/resources/finishes>

Enter your selection on “Support Panel HPL” line on the last page of this designator.

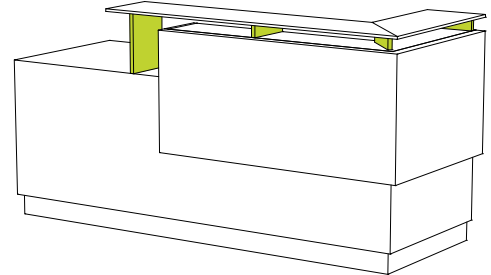

Step 7: Select HPL for Toe Kick.

See our selection of finish choices at <https://www.mediatechnologies.com/resources/finishes>

Enter your selection on “Toe Kick HPL” line on the last page of this designator.

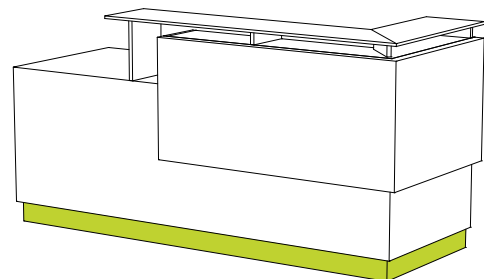

“How do I add finishes to...”

Milan

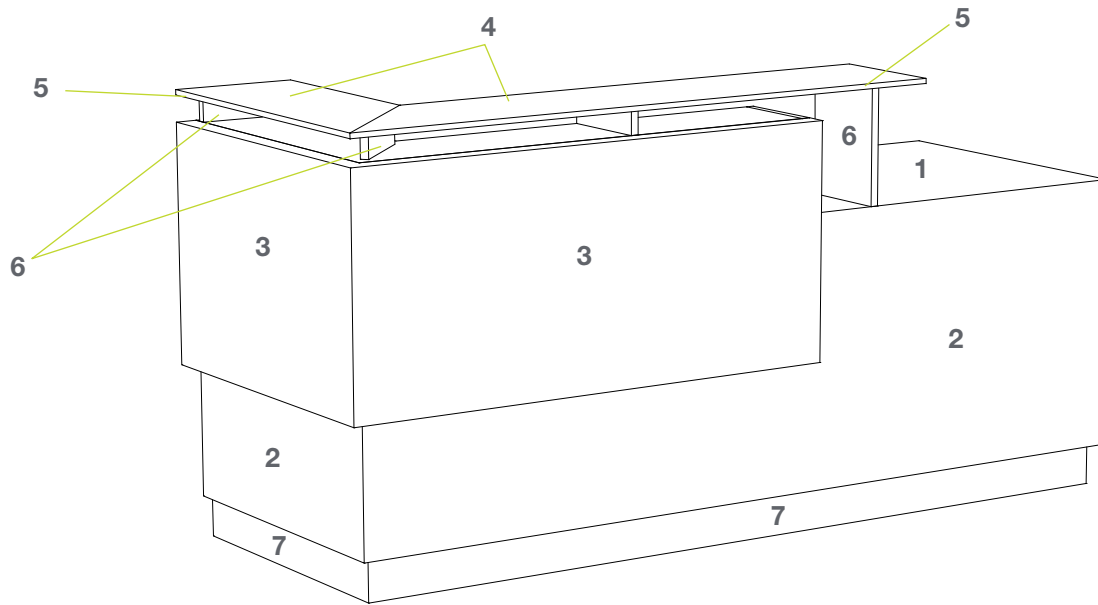

MLDL-C3084L-30

Job:

Model Number:

Finish Schedule:

1 Work Surface HPL:

2 Main HPL:

3 Accent HPL:

4 Transaction HPL::

5 Transaction PVC:

6 Support Panel HPL:

7 Toe Kick HPL:
